

ZX Evolution. User manual.
(ZX Evolution revision C)

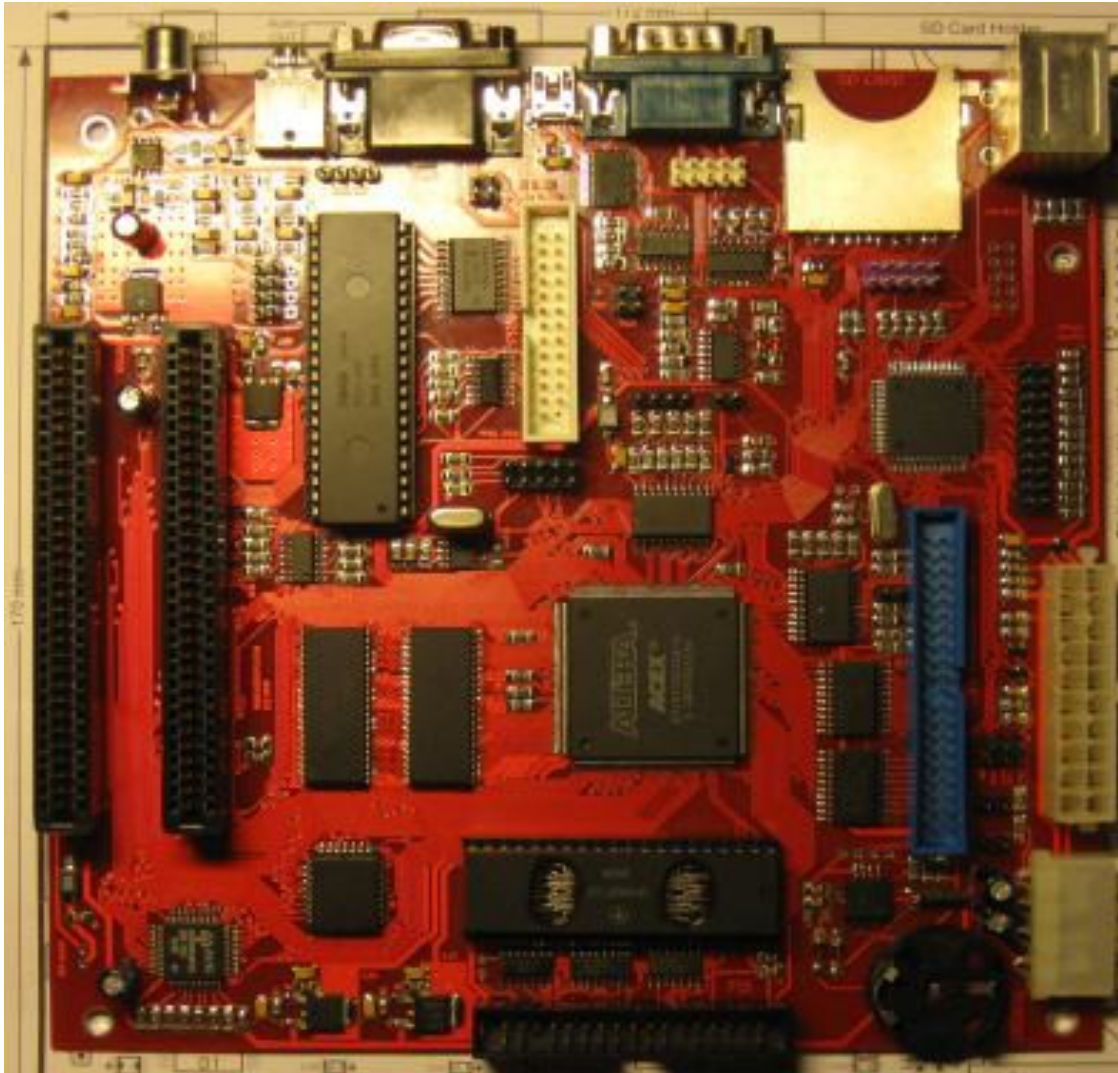

(version 03/25/2013)

www.nedopc.com

Table of contents

1 Introduction.....	3
2 Board layout.....	4
3 Connectors.....	5
3.1 X1. Floppy disk.....	5
3.2 X2. IDE.....	6
3.3 X3. Printer (non-full LPT).....	6
3.4 X4. JTAG for EP1K50Q208.....	7
3.5 X5. AVR ISP for ATMEGA128.....	7
3.6 X6. RS232 communication.....	8
3.7 X7. VGA.....	8
3.8 X8. RGB video out.....	9
3.9 X9. Video out power supply.....	9
3.10 X10. 3.5 Audio out.....	9
3.11 X11. PS/2 keyboard and mouse.....	9
3.12 X12. Joystick and original ZX keyboard.....	10
3.12.1 Using Kempston and Sinclair joysticks.....	10
3.13 X13. Mini USB (USB-RS232 bridge out).....	11
3.14 X14. AVR JTAG for ATMEGA128.....	11
3.15 X15. Tape in/out.....	11
3.16 X16. Audio out (duplicate X10).....	11
3.17 X17, X18, X20. Audio in.....	12
3.18 X19. RS232 communication (duplicate X6).....	12
3.19 X21. Tape IN (duplicate X15).....	12
3.20 PWR1. Power.....	12
3.21 PWR2. ATX power.....	13
3.22 GB1. Battery holder.....	13
4 Jumpers and button.....	14
5 ZXBUS slots.....	15
6 Installation ZX Evolution to miniITX/microATX/ATX case.....	17
7 ZX Evolution firmwares.....	18
8 Appendix 1. Connecting display.....	19
9 Appendix 2. Floppy drive.....	20
10 Appendix 3. Additional PS2 keyboard functions (only for “baseconf” configuration and “EVO reset service” ROM).....	21

1 Introduction

ZX Evolution is Spectrum compatible computer. Computer based on programmable logic device Altera EP1K50Q208 and has flexible architecture, but board content original main chips (Z80, sound coprocessor, floppy controller).

ZX Evolution board designed by miniITX standard for easy installation to miniITX, mATX or ATX case.

Main features:

- Z80 on 3.5MHz (standard)/7 MHz (turbo mode) without wait circles/14MHz (mega turbo mode) with wait circles;
- 4 MBytes RAM, 512KBytes ROM (flash ROM);
- MiniITX form factor, support ATX or +5v,+12v power supply;
- 2 ZXBUS slots;
- Peripheral controller ATMEGA128;
- PS/2 keyboard/mouse interface;
- IDE interface [parallel ATA] (one channel, up to 2 devices on master/slave mode);
- SD(HC) memory card interface;
- Floppy disk interface based on WDC1793 (support up to 4 drives);
- RS232 interface;
- Integrated RS232-USB bridge;
- Realtime/Calendar (RTC);
- Sound interfaces: AY38910/YM2149F, beeper, pwm;
- Joystick and mechanical (original) keyboard interface;
- Tape interface (input/output);
- RGB video out (SCART compatible);
- VGA (scan doubler).

2 Board layout

Layout of components and connectors on board:

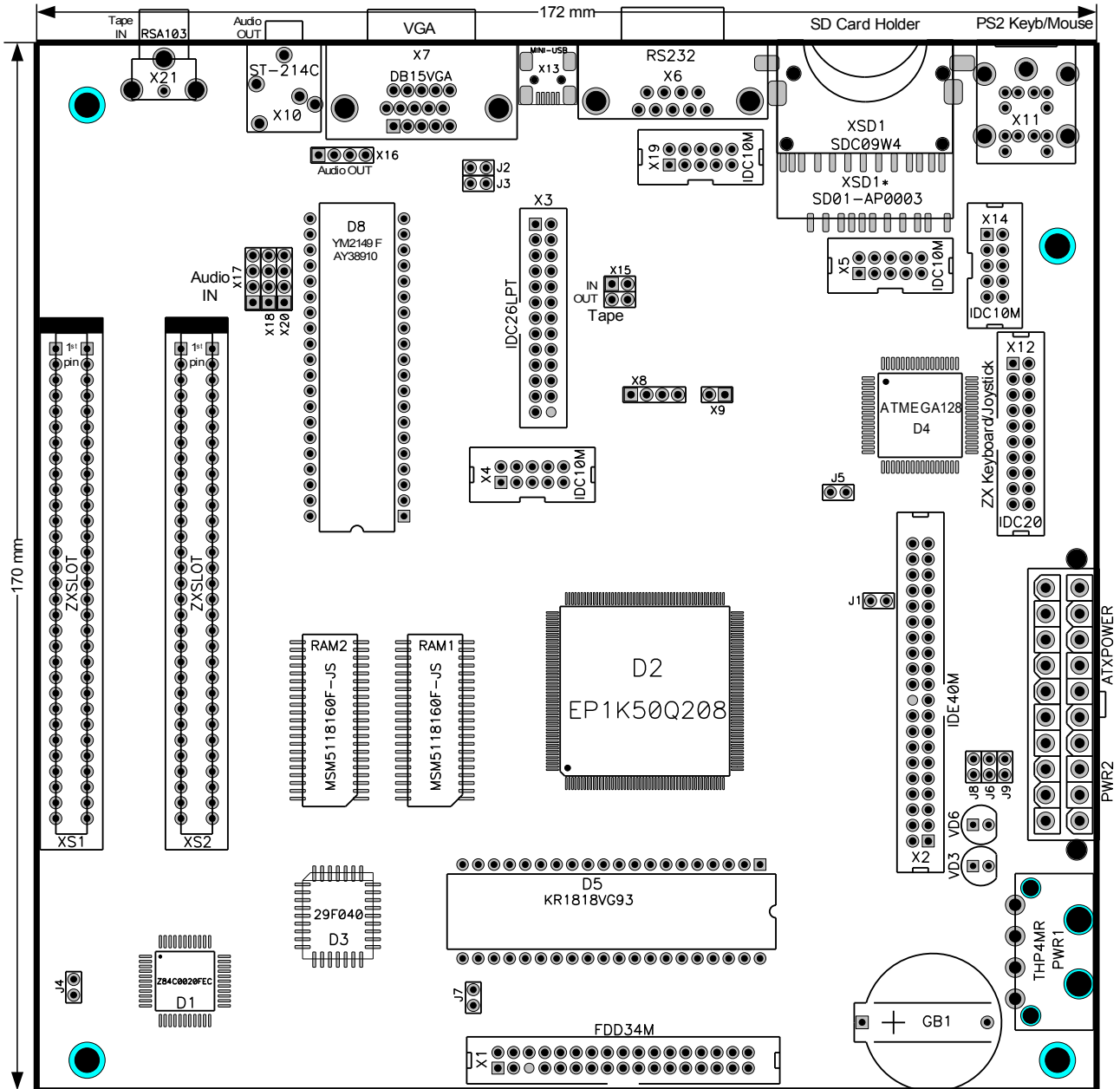

Most usable connectors place to ATX cases “window”.

Board use standard ATX or +5v,+12v power supply.

Warning: Only ZXBUS compatible devices may installed to slot (for example NeoGS sound card:

<http://www.nedopc.com/gS/ngs.php>).

3 Connectors

3.1 X1. Floppy disk

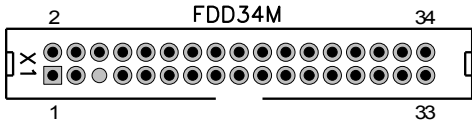

Connector for floppy drive[s] (3.5' or 5.25'). Supported up to four devices.

First pin have square pad.

Pins description:

№	Name	Description	№	Name	Description
1	GND	Ground	2		Not used
3	GND	Ground	4		Not used
5	KEY	key (no contact)	6	DS3	Select 3 drive (D)
7	GND	Ground	8	IDX	Index
9	GND	Ground	10	DS0	Select 0 drive (A)
11	GND	Ground	12	DS1	Select 1 drive (B)
13	GND	Ground	14	DS2	Select 2 drive (C)
15	GND	Ground	16	MOTON	Motor on
17	GND	Ground	18	DIRC	Direction
19	GND	Ground	20	STEP	Step
21	GND	Ground	22	WD	Write data
23	GND	Ground	24	WG	Write enable
25	GND	Ground	26	TR00	Track 0
27	GND	Ground	28	WP	Write protect
29	GND	Ground	30	RDDATA	Read data
31	GND	Ground	32	SIDE1	Side select
33	GND	Ground	34		Not used

3.2 X2. IDE

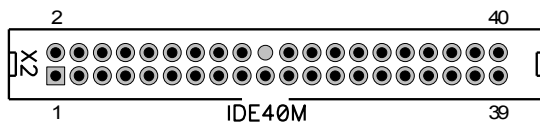

Connector for IDE (parallel ATA) drives. Supported up to two drives on master/slave mode.

First pin have square pad.

Pins description:

№	Name	Description	№	Name	Description
1	RESET	Reset	2	GND	Ground
3	D07	Data7	4	D08	Data8
5	D06	Data6	6	D09	Data9
7	D05	Data5	8	D10	Data10

9	D04	Data4	10	D11	Data11
11	D03	Data3	12	D12	Data12
13	D02	Data2	14	D13	Data13
15	D01	Data1	16	D14	Data14
17	D00	Data0	18	D15	Data15
19	GND	Ground	20	KEY	KEY (no contact)
21		Not used	22	GND	Ground
23	DIOW		24	GND	Ground
25	DIOR		26	GND	Ground
27	IORDY		28		Not used
29		Not used	30	GND	Ground
31		Not used	32		Not used
33	DA1	Address1	34		Not used
35	DA0	Address0	36	DA2	Address1
37	CS0	Select0	38	CS1	Select
39	DASP	Indicator	40	GND	Ground

3.3 X3. Printer (non-full LPT).

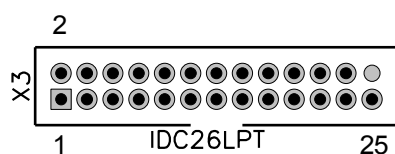

Connector for Printer (recommends to use EPSON-compatible printer).
First pin have square pad.

Pins description:

№	Name	Description	№	Name	Description
1	STROBE	Strobe	2		Not used
3	DATA0	0 bit of data	4	ERROR	Error
5	DATA1	1 bit of data	6		Not used
7	DATA2	2 bit of data	8		Not used
9	DATA3	3 bit of data	10	GND	Ground
11	DATA4	4 bit of data	12	GND	Ground
13	DATA5	5 bit of data	14	GND	Ground
15	DATA6	6 bit of data	16	GND	Ground
17	DATA7	7 bit of data	18	GND	Ground
19		Not used	20	GND	Ground
21	BUSY	Busy	22	GND	Ground
23	PE	Paper end	24	GND	Ground
25		Not used	26	KEY	KEY (no contact)

3.4 X4. JTAG for EP1K50Q208

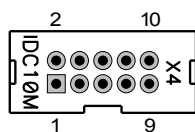

Connector for programming FPGA EP1K50Q208 via JTAG interface (with ByteBlasterMV or other programming device).
First pin have square pad.

Pins description:

№	Name	Description	№	Name	Description
1	TCK	Clock	2	GND	Ground
3	TDO	Data output	4	3V3	Power +3.3V
5	TMS	Mode select	6		Not used
7		Not used	8		Not used
9	TDI	Data input	10	GND	Ground

3.5 X5. AVR ISP for ATMEGA128

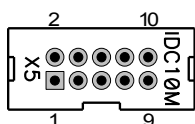

Connector for programming ATMEGA128 via ISP (with ByteBlasterMV or other programming device).
First pin have square pad.

Pins description:

№	Name	Description	№	Name	Description
1	CK	Clock	2	GND	Ground
3	DO	Data output	4	VCC5	Power +5V
5	RST	Reset	6		Not used
7		Not used	8	EXCLOCK	External clock
9	DI	Data input	10	GND	Ground

3.6 X6. RS232 communication

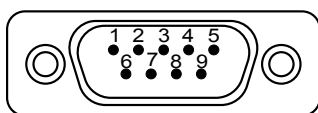

Communication port used for connection with other computer or communicating devices (for example modem). Up to 115200BOD transfer speed.

Pins description:

№	Name	Description	№	Name	Description
1		Not used	6		Not used
2	RXD	Receive data	7	RTS	Request to send
3	TXD	Transmit date	8	CTS	Clear to send
4		Not used	9		Not used
5	GND	Ground	Shield		Connected to ground

3.7 X7. VGA

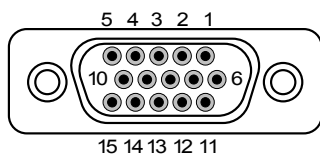

Connector for monitor or TV.

Warning: Monitor or TV must support 50Hz, 31KHz video rate. Please refer to monitor manual or compatible monitors list:

http://www.nedopc.com/zxevo/zxevo_supported_monitors.pdf .

Pins description:

№	Name	Description	№	Name	Description
1	R	Red	9	VIDEOVCC	J3 open: not used J3 short: +5V
2	G	Green	10	GND	Ground
3	B	Blue	11	GND	Ground
4		Not used	12		Not used
5		Not used	13	HS	Horizontal synchronization
6	GND	Ground	14	VS	Vertical synchronization
7	GND	Ground	15	CSYNC	J2 open: not used J2 short: composite synchronization
8	GND	Ground	Shield		Shield connect to ground

3.8 X8. RGB video out

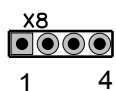

Connector for monitors or TV (via SCART).

Recommends to use couple with X9 for PAL coder.

First pin have square pad.

Pins description:

№	Name	Description	№	Name	Description
1	R	Red	2	G	Green
3	B	Blue	4	CSYNC	Composite synchronization

3.9 X9. Video out power supply



1. GND – ground;

2. VIDEOVCC – +5V.

Recommends to use couple with X8 for PAL coder.

First pin have square pad.

3.10 X10. 3.5 Audio out

Connector for headphone or speaker.

Shield connect to ground.

3.11 X11. PS/2 keyboard and mouse

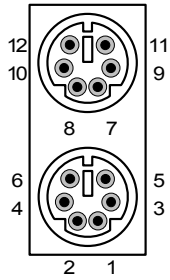

Connector for PS/2 keyboard and mouse. Keyboard connect into near from board (bottom) socket. Mouse connect into far from board (top) socket. Shield connect to ground.

Pins description:

№	Name	Description	№	Name	Description
1	DATA	Keyboard data	7	DATA	Mouse data
2		Not used	8		Not used
3	GND	Ground	9	GND	Ground
4	+5V	Power +5V	10	+5V	Power +5V
5	CLK	Keyboard clock	11	CLK	Mouse clock
6		Not used	12		Not used

3.12 X12. Joystick and original ZX keyboard

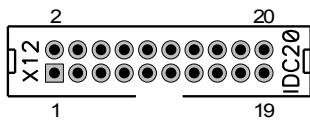

Connector for original ZX keyboard or joystick. First pin have square pad.

Pins description:

№	Name	Description	№	Name	Description
1	ZXROW0	0 row of original keyboard	2	ZXROW1	1 row of original keyboard
3	ZXROW2	2 row of original keyboard	4	ZXROW3	3 row of original keyboard
5	ZXROW4	4 row of original keyboard	6	ZXROW5	5 row of original keyboard
7	ZXROW6	6 row of original keyboard	8	ZXROW7	7 row of original keyboard
9	RST	Reset	10	ZXCOL4	4 column of original keyboard
11	ZXCOL3	3 column of original keyboard	12	ZXCOL2	2 column of original keyboard
13	ZXCOL1	1 column of original keyboard	14	ZXCOL0	0 column of original keyboard
15	GND	Ground	16	JOYL	Left of joystick
17	JOYR	Right of joystick	18	JOYU	Up of joystick
19	JOYD	Down of joystick	20	JOYF	Fire of joystick

3.12.1 Using Kempston and Sinclair joysticks

Sinclair 1			Sinclair 2			Kempston	
Function	ZX keyboard button	X12 shorted pins	Function	ZX keyboard button	X12 shorted pins	Function	X12 shorted pins
left	1	4 - 14	left	6	5 - 10	left	15 - 16
right	2	4 - 13	right	7	5 - 11	right	15 - 17
down	3	4 - 12	down	8	5 - 12	up	15 - 18
up	4	4 - 11	up	9	5 - 13	down	15 - 19
fire	5	4 - 10	fire	0	5 - 14	fire	15 - 20

3.13 X13. Mini USB (USB-RS232 bridge out)

For connecting to other computer in USB-slave mode.

3.14 X14. AVR JTAG for ATMEGA128

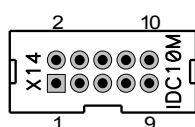

Connector for programming ATMEGA128 via JTAG ICT. First pin have square pad.

Pins description:

№	Name	Description	№	Name	Description
1	TCK	Clock	2	GND	Ground
3	TDO	Data output	4	VCC	Power +5V
5	TMS	Mode select	6	PRGRST	Reset
7	VCC	Power +5V	8		Not used
9	TDI	Data input	10	GND	Ground

3.15 X15. Tape in/out

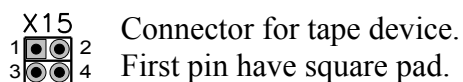

Connector for tape device. First pin have square pad.

Pins description:

№	Name	Description	№	Name	Description
1	IN	Tape input	2	GND	Ground
3	OUT	Tape output	4	GND	Ground

3.16 X16. Audio out (duplicate X10)

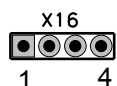

Connector for headphone or speaker. First pin have square pad.

Pins description:

№	Name	Description	№	Name	Description
1	LOUT	Left	2	GND	Ground
3	GND	Ground	4	ROUT	Right

3.17 X17, X18, X20. Audio in

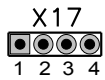

Connector for external audio sources (for example CDRom, NeoGS, TurboSound).
First pin have square pad.

Pins description:

№	Name	Description	№	Name	Description
1	LIN	Left	2	GND	Ground
3	GND	Ground	4	RIN	Right

3.18 X19. RS232 communication (duplicate X6)

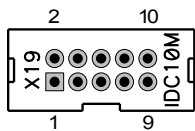

Communication port used for connection with other computer or communicating devices (for example modem). Up to 115200BOD transfer speed.
First pin have square pad.

Pins description:

№	Name	Description	№	Name	Description
1		Not used	2	RXD	Receive data
3	TXD	Transmit data	4		Not used
5	GND	Ground	6		Not used
7	RTS	Request to send	8	CTS	Clear to send
9		Not used	10	VCC	+5V

3.19 X21. Tape IN (duplicate X15)

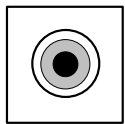

For connecting tape device.

3.20 PWR1. Power

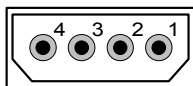

Connector for non-standard power supply (+12V, +5V, GND).

Pins description:

№	Name	Description	№	Name	Description
---	------	-------------	---	------	-------------

1	VCC5	Power +5V	3	GND	Ground
2	GND	Ground	4	VCC12	Power +12V

3.21 PWR2. ATX power

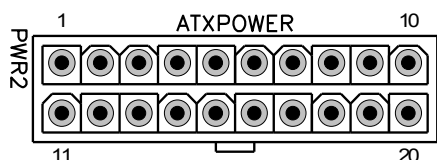

Connector for ATX power supply.

Pins description:

№	Name	Description	№	Name	Description
1		Not used	11		Not used
2		Not used	12		Not used
3	GND	Ground	13	GND	Ground
4	VCC5	Power +5V	14	PS_ON	Power on
5	GND	Ground	15	GND	Ground
6	VCC5	Power +5V	16	GND	Ground
7	GND	Ground	17	GND	Ground
8	PWRGOOD	Power is good	18		Not used
9	VCC5STBY	Standby +5V	19	VCC5	Power +5V
10	VCC12	Power +12V	20	VCC5	Power +5V

3.22 GB1. Battery holder

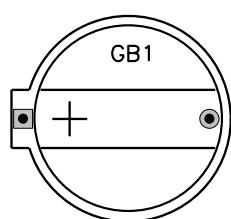

Holder for RTC battery.
Please use CR2032 batteries (3Volt).

4 Jumpers and button

№	Name	Default value	Description
J1	enable IDERES	opened	Enable IDE reset signal to IDE drives if shorted. It need to some old drives (for example Samsung 10Gb drives).
J2	enable composite sync to VGA	opened	Enable composite synchronization to VGA if shorted.
J3	enable +5V to VGA	opened	Enable +5V to VGA if shorted.
J4	12v enable	opened	Enable +12V power supply to slots if shorted.
J5	external clock	opened	Enable external clock to ATMEGA128 from AVR ISP connector (X5).
J6	soft reset key	opened	Soft reset or power switching: - connect «PWR SW» button from ATX case; - soft reset (without restart ATMEGA128) if shorted few time.
J7	HRDY->IP	opened	HRDY controlled IP pull-down to GND if closed.
J8	NMI key	opened	Set NMI to Z80 if shorted.
J9	hard reset key	opened	Hard reset (with restart ATMEGA128) if shorted. Connect «Reset» button of AT or ATX case.
VD3 ¹	HDD Led		Connect «HDD LED» from AT or ATX case.
VD6 ²	PWR Led		Connect «PWR LED» from AT or ATX case.

1 If set contacts instead VD3 led on board (for example boards from NedoPC).

2 If set contacts instead VD6 led on board (for example boards from NedoPC).

5 ZXBUS slots

ZX Evolution have two slots compatible to ZXBUS standard.

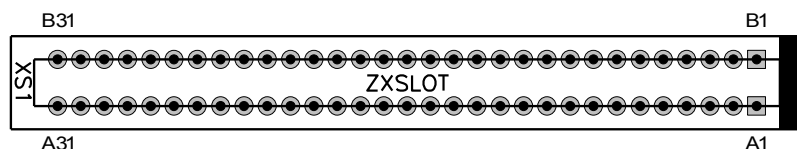

ZXBUS pin step is 2.54mm.

First pin have square pad. First pin is near to rear side of ATX case.

Warning: ZXBUS cards key must placed to first pins side of slot. If ZXBUS card not have key, please refer to ZXBUS card user manual. If you install ZXBUS card incorrectly than ZXEvolution board may be malfunction.

Warning: ZX Evolution developer not guaranteed correct working ZXBUS cards from other developers. ZX Evolution developer not test ZXBUS cards from other developers. Testing must be organized by ZXBUS cards developer.

Warning: If ZXBUS card need +12V power on slot than J4 jumper on ZX Evolution board must be shorted.

Slot pins description:

№	Name	Description	№	Name	Description
A1	A14	14 address line of CPU	B1	A15	15 address line of CPU
A2	A12	12 address line of CPU	B2	A13	13 address line of CPU
A3	+5V	Power +5V	B3	D7	7 data line of CPU
A4	DCDOS	TRDOS enabled	B4		Not used
A5		Not used	B5		Not used
A6	GND	Ground	B6	D0	0 data line of CPU
A7	GND	Ground	B7	D1	1 data line of CPU
A8		Not used	B8	D2	2 data line of CPU
A9	A0	0 address line of CPU	B9	D6	6 data line of CPU
A10	A1	1 address line of CPU	B10	D5	5 data line of CPU
A11	A2	2 address line of CPU	B11	D3	3 data line of CPU
A12	A3	3 address line of CPU	B12	D4	4 data line of CPU
A13	IORQGE	Disable other devices (io catch)	B13	INT	Interrupt
A14	GND	Ground	B14	NMI	Non masked interrupt
A15	CSROMCE	Enable ROM selection	B15	HALT	CPU halt
A16	RS	Switch ROM pages	B16	MREQ	CPU memory request
A17		Not used	B17	IORQ	CPU io request
A18		Not used	B18	RD	CPU read data
A19	BUSRQ	CPU bus request	B19	WR	CPU write data
A20	RES	Reset	B20		Not used

ZX Evolution. User manual

A21	A7	7 address line of CPU	B21	WAIT	CPU wait
A22	A6	6 address line of CPU	B22		Not used
A23	A5	5 address line of CPU	B23		Not used
A24	A4	4 address line of CPU	B24	M1	M1 state of CPU
A25	CSROM	ROM selected	B25	RFSH	Refresh
A26	BUSAK	CPU bus acknowledge	B26	A8	8 address line of CPU
A27	A9	9 address line of CPU	B27	A10	10 address line of CPU
A28	A11	11 address line of CPU	B28	+5V	Power +5V
A29	+5V	Power +5V	B29	+12V	Power +12V
A30	GND	Ground	B30	GND	Ground
A31		On XS1: IORQGE2 On XS2: not used	B31		On XS1: IORQ2 On XS2: not used

6 Installation ZX Evolution to miniITX/microATX/ATX case

ZX Evolution board designed for easy installing to miniITX, microATX or ATX case.

Warning: ZX Evolution not completed with brackets and fixates.

Steps:

1. Set CR2032 battery or compatible to GB1 holder on board.
2. Set board to cases frame. Set frame into case. Connectors (X21, X10, X7, X13, X6, XSD1, X11) must placed to “window” on rear side of case.
3. Connect cases power supply to PWR2.
4. Connect RES SW (from «Reset» button on case) to J9 (hard reset) on board.
5. Connect PWR SW (from «Power» button on case) to J6 (soft reset) on board.
6. Connect IDE LED (from «Ide» led on case) to VD3³ on board (positive contact have square pad).
7. Connect PWR LED (from «Power» led on case) to VD6⁴ on board (positive contact have square pad).
8. Set floppy drive(s)⁵ into case, connect power supply to drive(s) and connect to X1 via ribbon cable.
Warning: Ribbon cable of floppy drive not compatible with standard PC ribbon cable. Scheme of ribbon cable see in appendix.
9. Set IDE drive(s)⁶ into case, connect power supply to drive(s) connect to X2 via ribbon cable.
Warning: Installing two IDE drives may be only in master/slave mode.

Power supply controlled like PC realization:

Operation	Action
Power ON (for ATX power supply)	<ul style="list-style-type: none"> • Short briefly «soft reset» [J6] (PWR SW) or • Short briefly «hard reset» [J9] (RES SW)
Power OFF (for ATX power supply)	<ul style="list-style-type: none"> • Short «soft reset» [J6] (PWR SW) to 5 second duration
CPU reset	<ul style="list-style-type: none"> • Short briefly «soft reset» [J6] (PWR SW)
Full reset	<ul style="list-style-type: none"> • Short briefly «hard reset» [J9] (RES SW)

³ If set contacts instead VD3 led on board (for example boards from NedoPC).

⁴ If set contacts instead VD6 led on board (for example boards from NedoPC).

⁵ Floppy drive is not mandatory, ZX Evolution work normally without it.

⁶ IDE drive is not mandatory, ZX Evolution work normally without it.

7 ZX Evolution firmwares

ZX Evolution content MCU ATMEGA128 and EPROM 29F040.

MCU ATMEGA128 is next functionality:

- Control peripheral devices, convert interfaces to ZX Spectrum standards;
- Load configuration to EP1K50QC208 on power up or «hardware» reset of ZX Evolution;
- Update firmwares.

Firmware ATMEGA128 content two parts:

- **BOOTLOADER** – non-modified part for update or modify other firmware part of MCU (see documentation of bootloader⁷). This part flashed by special MCU-programmer device. You can update bootloader on new release only via special MCU-programmer device.
- **Configuration** – part, whose control peripheral devices and load EP1K50QC208. Some developers can to create different configurations. Exist service configuration for tuning and testing ZX Evolution board. Configurations stores in special file **zxevo_fw.bin** .

Warning: NedoPC support two configurations:

- **TEST&SERVICE** – configuration for tuning and testing ZX Evolution after soldering. This configuration can flash EPROM 29F040;
- **BASECONF** – base configuration. This configuration is base and example for ZX Evolution. Base configuration developed by NedoPC. Other developers can use source of base configuration like example for own configurations.

Warning: NedoPC not support configurations from other developers and not guaranteed correct functionality of ZX Evolution.

EPROM 29F040 content Z80 subprograms for working ZX Evolution in ZX Spectrum mode (Basic48, Basic128, TRDOS and etc). Flashing image stored in binary file **zxevo.rom** (size of image must correspond size of EPROM 29F040). Other developers may arrange of EPROMs content on own needs.

You can use **TEST&SERVICE** configuration for flashing or updating EPROM:

- Upload **TEST&SERVICE** configuration to ZX Evolution via **BOOTLOADER**;
- Copy **zxevo.rom** to SD memory card and set it on ZX Evolution;
- Select “update” menu in **TEST&SERVICE** configuration and flash EPROM;
- Upload working configuration (for example **BASECONF**) via **BOOTLOADER** to ZX Evolution.

Warning: NedoPC version of EPROM image based on **EVO RESET SERVICE**. This version of EPROM used in couple with **BASECONF** configuration from NedoPC. Updating new version **BASECONF** and EPROM image recommend in same time, cause new version of **BASECONF** may not work with old version of EPROM and vise verse. **EVO RESET SERVICE** can update EPROM in itself (see documentation).

⁷ http://www.nedopc.com/zxevo/rom/zxevo_firmware_update_eng.pdf

8 Appendix 1. Connecting display

ZX Evolution can use two types of monitors:

- VGA monitors;
- TV-monitors.

VGA monitors connect via VGA (X7) connector on ZX Evolution.

Warning: Switch VGA/TV mode of ZX Evolution by “Scroll Lock” keyboard button (If you use BASECONF firmware from NedoPC). “Scroll Lock” keyboards indicator light in VGA mode.

Warning: VGA monitor must support 48.8 Hz for using with ZX Evolution. List of supported monitors are in ZX Evolution project page⁸.

ZX Evolution revision C content special connector (X8, X9) for RGB TV monitor. You can connect monitor via SCART-RGB connector on TV or via PAL-coder⁹.

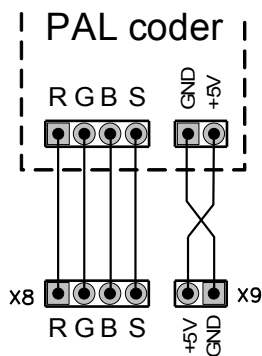

Connecting via PAL-coder require special cable like shown in scheme.

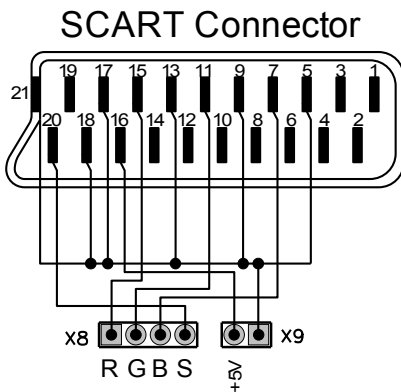

Connecting via SCART require special cable like shown in scheme.

Warning: TV monitor must support RGB mode in SCART.

You can use VGA (X7) connector for connecting TV-monitors. You must short J2 and J3 for required signals (composite synchronization and +5V power) on X7 in this case.

⁸ http://www.nedopc.com/zxevo/zxevo_supported_monitors.pdf

⁹ <http://www.nedopc.com/PALCODER/palcoder.php>

9 Appendix 2. Floppy drive

Floppy controller on ZX Evolution distinguish from PC controller in selecting drives method. Floppy controller based on WDC1793 support up to four floppy drives.

PC floppy drives is selected like “B” drive on ZX Evolution by default. For connecting two drives to ZX Evolution use special ribbon cable:

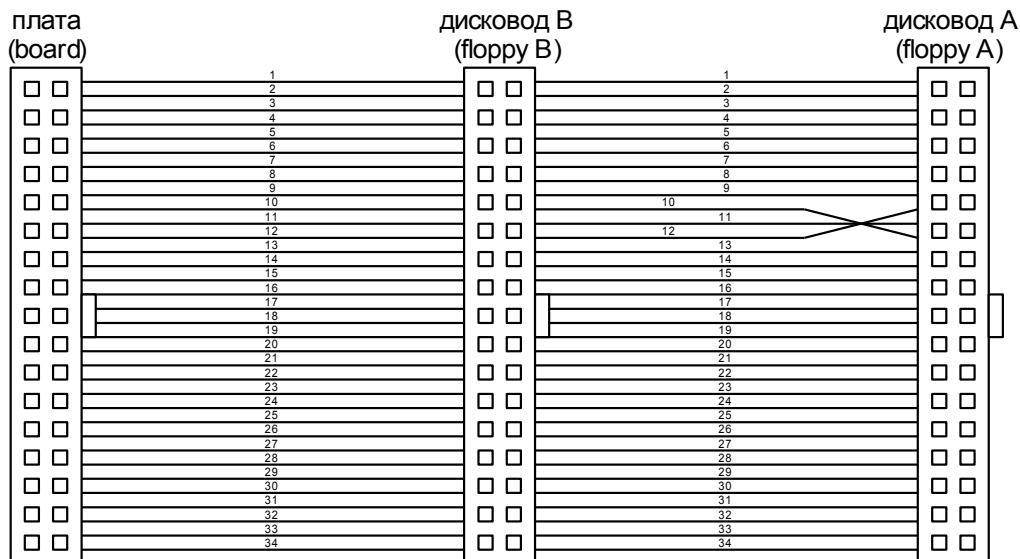

TRDOS use double density (DD) diskettes. Some modern floppy drives not support DD diskettes, it need to correcting hardware.

Close hole by non-transparent glue-tape on HD 3.5 diskettes for using it in DD mode (floppy drive detect it like double density diskette).

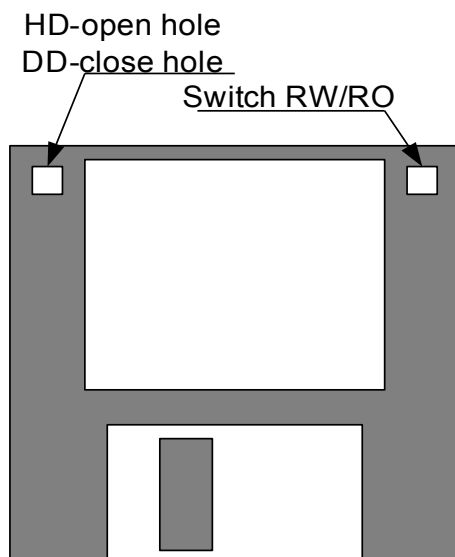

10 Appendix 3. Additional PS2 keyboard functions (only for “baseconf” configuration and “EVO reset service” ROM).

PS2 keyboard combination	Function
“F12”	Soft reset. Equal to “soft reset” [J6] jumper on board. Reset CPU only (without reconfiguration). Warning: If “F12” pressed 5 second then power switch off (only for ATX power supply).
“Ctrl”+“Alt”+“Del”	Hard reset. Equal to “hard reset” [J9] jumper on board. Reset and reconfiguration ZXEvo board.
“ScrollLock”	Switch VGA/TV mode for video out. Keyboards led “ScrollLock” is light on VGA mode.
“PrintScreen”	Generate NMI (non-masked interrupt) to CPU.
“NumLock”	Switch tapeout/beeper mode for line out. Keyboards led “NumLock” is light on tapeout mode.
left mouse button + right mouse button + numpad “*”	Reset mouse resolution to default value.
left mouse button + right mouse button + numpad “+”	Increase mouse resolution.
left mouse button + right mouse button + numpad “_”	Decrease mouse resolution.
”0”(zero) + “F12”	(press “0”, press “F12”, unpress “F12”, unpress “0”) Set ROM to “Evo service” mode.